

OWNER'S/ OPERATOR'S MANUAL

**MODEL NO.
HHU-2045**

CAUTION

For Safe Operation
Read Rules And
Instructions Carefully

SI NO LEEINGLES, PIDA AYUDA
A AIGUIEN QUE SI LO LEA
PARA QUE LE TRADUZCA LAS
MEDIDAS DE SEGURIDAD.

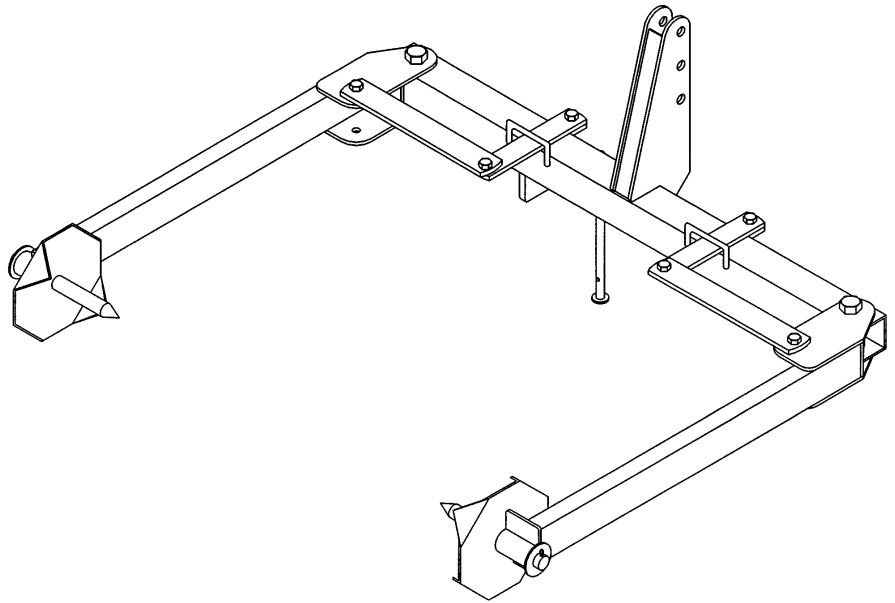

HAY HANDLER / UNROLLER

Safety Instructions
Tractor Preparation
Operating Instructions

Assembly & Mounting
Maintenance
Repair Parts

CAUTION

**THE FOLLOWING SAFETY PRECAUTIONS SHOULD BE THOROUGHLY UNDERSTOOD
BEFORE ATTEMPTING TO BEGIN ASSEMBLING THIS MACHINE**

1. Select an area for assembly that is clean and free of any debris which might cause persons working on the assembly to trip.
2. Do not lift heavy parts or assemblies. Use crane, jack, tackle, fork trucks or other mechanical devices.
3. Preview the assembly instructions in your operator's manual before proceeding further.
4. If the assembly instructions call for parts or assemblies to be blocked up, use only blocking material that is in good condition and is capable of handling the weight of the assembly to be blocked. Also insure that the blocking material is on a clean, dry surface.
5. Never put hands, or any part of body, under blocked up assemblies if at all possible.
6. After completing assembly, thoroughly inspect the machine to be sure that all nuts, bolts, hydraulic fittings or any other fastened assemblies have been thoroughly tightened.
7. Before operating the machine, thoroughly read the operation section of your operator's manual.
8. Before operating, read the maintenance section of your operator's manual to be sure that any parts requiring lubrication, such as gearboxes, are full, to avoid any possible damage.
9. **Before operating equipment – If you have any questions regarding the proper assembly or operation, contact your dealer or representative.**

To the Owner/Operator/Dealer

All implements with moving parts are potentially hazardous. There is no substitute for a cautious, safe-minded operator who recognizes the potential hazards and follows reasonable safety practices. The manufacturer has designed this implement to be used with all its safety equipment properly attached to minimize the chance of accidents.

BEFORE YOU START!!

**Read the safety messages on the implement and shown in your manual.
Observe the rules of safety and common sense!**



THIS SYMBOL MEANS

- ATTENTION!
- BECOME ALERT!
- YOUR SAFETY IS INVOLVED!

THIS SAFETY ALERT SYMBOL IDENTIFIES IMPORTANT SAFETY WARNING MESSAGES. CAREFULLY READ EACH WARNING MESSAGE THAT FOLLOWS. FAILURE TO UNDERSTAND AND OBEY A SAFETY WARNING, OR RECOGNIZE A SAFETY HAZARD, COULD RESULT IN AN INJURY OR DEATH TO YOU OR OTHERS AROUND YOU. THE OPERATOR IS ULTIMATELY RESPONSIBLE FOR THE SAFETY OF HIMSELF, AS WELL AS OTHERS, IN THE OPERATING AREA OF THE TRACTOR AND EQUIPMENT.

UNDERSTAND SIGNAL WORDS



DANGER

Indicates an imminently hazardous situation that, if not avoided, WILL result in DEATH OR VERY SERIOUS INJURY.



WARNING

Indicates a imminently hazardous situation that, if not avoided, COULD result in DEATH OR SERIOUS INJURY.



CAUTION

Indicates a imminently hazardous situation that, if not avoided, MAY result in MINOR INJURY.

NOTE: *Identifies points of particular interest for more efficient and convenient operation or repair.*

Important Safety Information!













Read this manual, and the manual for your tractor, before assembly or operating, to acquaint yourself with the machine. It is the equipment owner's responsibility, if this equipment is used by any person other than yourself, is loaned or rented, to make certain that the operator, prior to operating:

1. Reads and understands the operator's manuals.
2. Is instructed in safe and proper use.



The use of this equipment is subject to certain hazards which cannot be protected against by mechanical means or product design. All operators of this equipment must read and understand this entire manual, paying particular attention to safety and operating instructions, prior to using. If there is something in this manual you do not understand, ask your supervisor, or your dealer, to explain it to you.

SAFETY INSTRUCTIONS (continued)

-  Keep all helpers and bystanders fifty feet (50') from operating equipment. Only properly trained people should operate this tractor and attached implement. It is recommended the tractor be equipped with a Rollover Protection System (ROPS) and a seat belt that is used. Always stop the tractor, set brake, shut off the tractor engine, remove the tractor key, and lower implement to the ground before dismounting tractor. Never leave equipment unattended with the tractor running.
-  All equipment is potentially hazardous. There is no substitute for a cautious, safe-minded operator who recognizes potential hazards and follows reasonable safety practices.
-  Start tractor only when properly seated in the tractor seat. Starting a tractor in gear can result in injury or death. Do not mount or dismount the tractor while the tractor is moving. Mount or dismount the tractor only when the tractor and all moving parts are completely stopped.
-  Operate the tractor and/or implement controls only while properly seated in the tractor seat with the seat belt securely fastened around you. Inadvertent movement of the tractor or implement may cause serious injury or death.
-  Be particularly careful when transporting the implement with the tractor. Turn curves or go up hills only at a low speed and using a gradual steering angle. Rear mounted implements move the center of gravity to the rear and remove weight from the front wheels. Make certain, by adding front ballast, that at least 20% of the tractor's weight is on the front wheels to prevent rearing up, loss of steering control or tractor tip-over. Slow down on rough or uneven surfaces to prevent loss of steering control which could result in property damage or possible injury. Do not transport unless 3-point lift lever is fully raised and in the transport position. Dropping implement in transport can cause serious damage to the tractor and/or implement and possibly cause the operator or others to be injured or killed.
-  BEFORE leaving the tractor seat, lower the implement, set the parking brake and/or set the tractor transmission in parking gear, disengage the PTO, stop the engine, remove the key, and wait for all moving parts to stop. Place the tractor shift lever into a low range or parking gear to prevent the tractor from rolling. Never dismount a tractor that is moving or while the engine is running. Operate the tractor controls from the tractor seat only.
-  Never leave the tractor and implement unattended while the implement is in the lifted position. Accidental operation of lifting lever or a hydraulic failure may cause sudden drop of unit with injury or death by crushing.
-  Never use alcoholic beverages or drugs which can hinder alertness or coordination while operating equipment. Consult your doctor about operating tractor and implement while taking prescription medications.
-  Do not allow children or others to ride on the tractor with an operator. Riders are subject to injury such as being struck by foreign objects or being thrown off. Riders obstruct the operator's view resulting in unsafe operation. **Never allow anyone to ride on the implement!**
-  Never allow children to play on or around tractor or implement. Children can slip or fall off the equipment and be injured or killed. Inadvertent contact with controls can cause the implement to shift or fall crushing themselves or others.
-  Do not allow anyone who is not familiar with the safety rules and operation instructions to use this equipment.
-  Do not exceed lift capacity of the tractor hitch.
-  Keep alert and watch the rear as well as the front when working with the attached implements.

SAFETY INSTRUCTIONS (continued)



This equipment is dangerous to children and persons unfamiliar with its operation. The operator should be a responsible adult familiar with farm machinery and trained in this equipment's operations. **Do not allow persons to operate or assemble this unit until they have read this manual and have developed a thorough understanding of the safety precautions and of how it works.**



A heavy load can cause instability of the tractor. Use extreme care during travel. Slow down on turns and watch out for bumps. The tractor may need front counter-weights to counter-balance the weight of the implement and load. An unstable tractor could steer badly and possibly tip over, causing injury or death.



Only use a tractor equipped with a ROPS cab or roll-over protective structure. Keep foldable ROPS systems in "locked up" position at all times. Keep seat belt fastened.



Know your controls and how to stop tractor and engine quickly in an emergency. **READ THIS MANUAL AND THE ONE PROVIDED WITH YOUR TRACTOR.**



When handling round bales on a slope, always approach the bale with the tractor facing uphill.



Never use the tractor/loader to stop a rolling bale.



Always load rear of tractor first and unload last when using a front loader.



Use extreme care and maintain minimum ground speed when transporting on hillside, over rough ground and when operating close to ditches or fences. Be careful when turning sharp corners.



Allow for additional length of implement and bale on tractor while turning.



Never exceed the limits of a piece of machinery. If its ability to do a job, or to do so safely, is in question – **DON'T TRY IT.**



Carry the load slowly. Avoid excessive speed during operation.



Periodically tighten all bolts, nuts and screws and check that all cotter pins are properly installed to ensure unit is in a safe condition.



Openings in the skin and minor cuts are susceptible to infection from hydraulic fluid. If injured by escaping hydraulic fluid, see a doctor at once. Gangrene and death can result. Without immediate medical treatment, serious infection and reactions can occur.



Do not modify the equipment in any way. Unauthorized modification may impair the function and/or safety and could affect the life of the equipment.







Before operating equipment: if you have any questions regarding the proper assembly or operation, contact your dealer or representative.

SAFETY INSTRUCTIONS (continued)



TRANSPORT SAFETY

-  Comply with state and local laws governing highway safety and movement of farm machinery on public roads.
-  When driving the tractor and equipment on the road or highway under 20 mph (32 kph) at night or during the day, use flashing amber warning lights and a slow moving vehicle (SMV) identification emblem.
-  Reduce speed when transporting mounted implements to avoid bouncing and momentary loss of steering control.
-  Turn curves or go up or down hills only at a low speed and at a gradual steering angle. Make certain that at least 20% of the tractor's weight is on the front wheels to maintain safe steering. Slow down on rough or uneven surfaces, and loose gravel.
-  Make sure large round bales transported on tractor rear 3 pt. hitch do not obstruct visibility of tractor's flashing lights or SMV sign.

SAFETY SIGNS

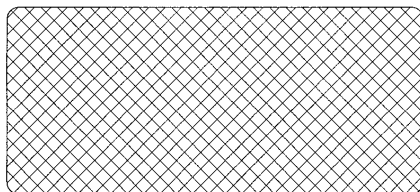

101209



WARNING

- Read and follow owner's manual before installing, operating, or performing maintenance on this attachment. Observe safety recommendations in manual.
- Do not exceed weight limit of attachment or tractor.
- Do not lift or carry anyone on attachment.
- Attachment should be used with the proper weight package on front of tractor or with a loader installed. When handling loads on both ends of tractor, load rear first and unload last.
- Set wheels wide for increased stability.
- Never raise load to extreme heights on steep inclines.
- When handling large round bale, keep load as low as practical to maximize tractor stability.
- Make sure large round bale transported on tractor rear three point hitch attachment does not obstruct visibility of tractor's flashing lights or SMV sign.
- Do not stand or work under raised attachment.
- Stop engine, lower arms, relieve all hydraulic pressure, and lock brakes before leaving operator's seat.
- Failure to observe the above precautions can result in serious injury or death.

101277

REPLACE SAFETY DECALS

If Safety Signs have been damaged, removed, become illegible or parts replaced without Signs, new Safety Signs must be applied. New Safety Signs are available from your authorized distributor or factory.

INSTRUCTIONS

INTRODUCTION

The Model HHU-2045 Hay Handler/Unroller is designed for use on Category II tractors with a 3 pt. hitch or a standard Category II quick hitch. It will also work on larger Category I tractors for handling small size bales, if the Category I tractor is properly equipped with front end weights.

The HHU-2045 will transport and unroll round bales up to 2000 pounds. The HHU-2045 will handle bales from 42" to 62" in width. The Hay Handler/Unroller can handle bale diameters up to 72" (6').

NOTE: The HHU-2045 is designed for transporting and unrolling large round hay bales only. **NEVER** attempt to use it for any other purpose.

TRACTOR REQUIREMENTS AND PREPARATION

The required size of the tractor will be determined by the size and weight of the bales to be handled.

Remember, high moisture hay (silage) bales are very heavy in relation to similar size dry hay bales.

Always use a tractor large enough to safely handle your bales.

Check the tractor's 3 point hydraulic lift system. It should operate up and down smoothly and hold its position when set. Refer to your tractor owner's manual or dealer for any adjustments necessary to put the 3 point hydraulic lift system in good working order. (I&T shop manuals will list most specifications and adjustment instructions – available from most farm equipment dealers.)

Check the hydraulic system. Be sure the tractor hydraulic oil and filter have been serviced according to the tractor manufacturer's recommendations.

Tractor should be equipped with stabilizer bars, adjustable sway chains, or sway blocks to keep the implement from swinging side to side.

Smaller size tractors may need front counter weights to counter-balance the weight of the implement.

It is recommended that the tractor be equipped with a Rollover Protection System (ROPS) and a seat belt that is used.



CAUTION

Be sure your tractor is in good condition. Read all the safety precautions and make sure all tractor operators are familiar with the safety rules of operation.



WARNING

When using the unit, a minimum 20% of tractor and equipment weight must be on tractor front wheels. Without this weight, tractor could tip up, causing possible loss of control and possible personal injury or death. The weight may be attained with a front end loader, front wheel weights, ballast in tires or front tractor weights. When attaining a minimum 20% of tractor and equipment weight on the front wheels, you must not exceed the ROPS weight certification. Weigh the tractor and equipment. DO NOT GUESS OR ESTIMATE!

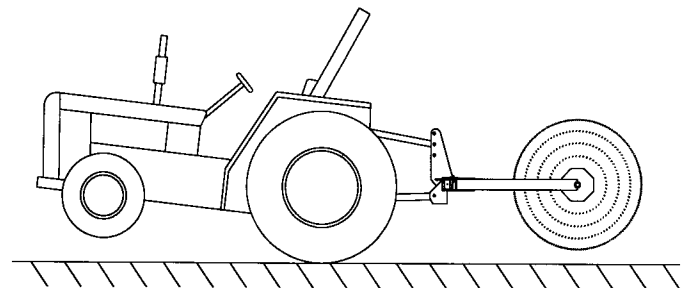

Figure 1. Tractor Stability



WARNING

A heavy load can cause instability in driving a tractor. Make sure the front of the tractor is properly counter-balanced with weights. Always drive slowly – especially around turns. An unstable tractor could steer badly and possibly tip over, causing injury or death.



WARNING

Power unit must be equipped with ROPS or ROPS cab and seat belt. Keep seat belt securely fastened. Falling off power unit can result in death from being run over or crushed. Keep foldable ROPS systems in "locked up" position at all times.

PACKAGING

The Hay Handler/Unroller is usually shipped as a bundle of parts on a pallet. The pallet should include 1 Main Frame Assembly, 1 Hardware Box, 2 Clamp Arms, and 2 Spike Spinner Assemblies.

NOTE: The cylinder pivot arms and push arms are in the Hardware Box.

NOTE: Hydraulic cylinder and hoses are not furnished.

INSTRUCTIONS (continued)

ASSEMBLY

It is suggested that all the instructions be read before beginning assembly.

Check the exploded view of the HHU-2045 in this manual to get an idea of the relationship of the parts.

Install the lift pins (Part No. 590078) into the pull brackets on the main frame. For Category I tractors, the pins go to the inside – for Category II tractors, the pins go to the outside of the brackets.

Connect the main frame assembly to the 3 pt. hitch of your tractor. Adjust the top link so that the main frame is near level and raise the hitch until the main frame is about 12" above the ground. Block the main frame with suitable blocking for safety.

The clamp arms are reversible to allow the Model HHU-2045 to handle a wide range of bale widths. (See Figure A.)

Assembling the clamp arms to the outside will provide a handling range for bales 52" to 62" in width. Assembling the arms to the inside allows the handling of narrower width bales, from 42" to 52".

NOTE: The bolts should be inserted with the head of the bolt against the welded tab on the clamp arm. This welded tab ensures that the bolt moves with the arm, which distributes the load over the entire bushing and bolt surface. This installation will result in one bolt head up and the other down.

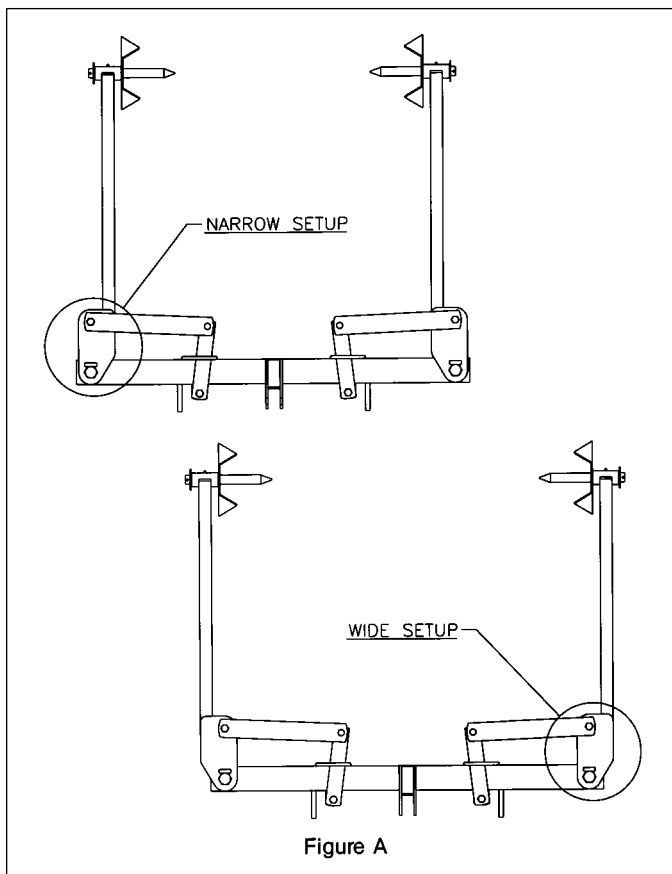

NOTE: It is recommended that a layer of grease be applied to the 1¹/₄" bolt and the top and bottom surface of the main frame prior to assembly. This provides good initial lubrication to the pivot.

Tighten the 1¹/₄" nuts until the looseness is gone from the clamp arm, but not so tight that the clamp arm won't swing easily.

Insert a cylinder pivot arm through the upside down "U" shaped bracket with the ³/₄" diameter hole forward. Install a ³/₄" x 2" bolt through the ³/₄" hole in the pivot arm and the tab on the front of the main frame. Install a ³/₄" nylock locking nut and tighten until the looseness is gone, but the arm can still move side to side within the "U" bracket. Repeat this on the other side.

Place one of the push arms **on top** of the front plates of the clamp arms and install the ³/₄" x 2" bolt with the nylock nut and tighten as described previously. Repeat this procedure on the other side.

Place the spike spinner assemblies into the horizontal sockets on each end of the clamp arms and secure with the thrust washers and 1/4" x 2¹/₂" cotter pin.

Lubricate with grease before using.

Place your hydraulic cylinder with the hydraulic ports on top into position at the center of the main frame. Connect each end of the hydraulic cylinder with the 1" cylinder clevis pins to both the push arm and the cylinder pivot arm (both arm ends are in cylinder clevis).

NOTE: Use a 2" x 8" or a 2¹/₂" x 8" double-acting hydraulic cylinder.

DO NOT USE A HYDRAULIC CYLINDER LARGER THAN 2¹/₂" DIAMETER.

Connect your hydraulic hoses to the hydraulic cylinder and to the remote hydraulic ports on the tractor. Make sure hydraulic hoses are routed so they will not be pinched by movement of the Hay Handler/Unroller or any parts of the 3 pt. linkage.

Start the tractor and raise the Hay Handler/Unroller and remove the blocking placed during assembly. Grease the clamp arm pivots and the spike spinner sockets at the end of the clamp arms.

Cycle the hydraulic cylinder several times to remove air from the cylinder and lines. Make sure area is clear, as clamp arms will swing out.

The operator is responsible for the safe operation of this equipment. The operator must be properly trained. Operators should be familiar with the tractor, loader and loader attachment, and all safety practices before starting operation. Read the safety rules.

INSTRUCTIONS (continued)

OPERATION

Make sure all operators have read all the safety warnings and precautions in this manual and those in the tractor operator's manual.

Be sure tractor is properly counterbalanced with weights before attempting to lift any load with the HHU-2045 Attachment.

If you are handling bales with both the front end loader and the 3 pt. hitch on the tractor, always load the 3 pt. attachment first and unload last.

Before using the Hay Handler/Unroller always raise the parking stand and pin in the raised position.

The Hay Handler/Unroller can be tilted within a wide range by choosing one of three (3) hole positions in the mast and by adjusting the top link. This adjustment range allows you to vary the height so that the clamp arm can be raised to best handle your size bales.

Before attempting to move or unroll a large round hay bale, examine the bale and determine which way the bale is wrapped. The bale needs to be gripped so it will unroll from the bottom as it is rolled forward on the ground.

Position your tractor square with the bale and open the clamp arms all the way. Back the tractor until the spike spinners are close to the center of the bale. Bales should be gripped at the center of the ends of the bale only. Close the clamp arms until the bale is gripped securely between the two spike spinner assemblies and raise the tractor's 3 pt. hitch.

The bale is ready for transport.

NOTE: In cold weather, a bale frozen to the ground may exceed the lifting capacity of HHU-2045 implement. Damage to implement may occur. Not covered under warranty.

When storing the Hay Handler/Unroller, lower the parking stand and pin. This will allow easy disconnect and re-connection with a Quick Hitch.

CAUTION

A heavy load can cause your tractor to tip over. When moving heavy loads, keep the load low, go slowly around turns, and be sure front of the tractor is properly counterbalanced with weights.

CAUTION

Be careful when backing up with a bale on the back of the tractor. Remember – visibility is limited. Check area carefully before backing.

CAUTION

When moving large round hay bales to a storage area – make sure storage area you select is level and that the hay bale will not roll when released. A rolling hay bale is dangerous and could cause injury or death.

UNROLLING HAY BALE

The Hay Handler/Unroller allows you to change your feeding area and eliminate the manure piles that can occur when using hay feeders.

You can control how much hay is fed to eliminate waste. Feed only an amount of hay that the cattle will clean up in one feeding. You may need to experiment with the amount for a few days to establish the correct amount. Allow for badly damaged or weathered hay.

By unrolling the hay in a long ribbon, all cattle have an equal opportunity to eat and the cattle are in a line for easy examination.

Before unrolling the bale, it is necessary to remove the twine or netting from the bale.

CAUTION

Make sure brakes are securely set before getting off the tractor. NEVER place any part of your body under the raised bale when removing twine or netting from the bale.

To unroll the bale, simply lower the bale to the ground and drive forward slowly. It may be necessary to continue lowering the bale to keep it in contact with the ground.

Keep a lookout forward to avoid any obstacles or livestock that might be in the way.

When you have unrolled the amount of hay you want to feed, raise the 3 pt. hitch and the bale will stop unrolling hay. Drive the unit outside the feeding area and the bale may be released for feeding the remainder at a later time.

MAINTENANCE & STORAGE

Periodically lubricate all pivot points and spinner assemblies with a good grade of grease.

Check all bolts to make sure they are properly tightened.

Check hydraulic hoses and fittings for leaks and replace or tighten as necessary. Make sure hoses are not being pinched or chafed by movement of unit or 3 pt. hitch linkage.

Replace safety decals if damaged or missing.

Storage location should be level and solid to make hitching and unhitching easy. Store in a clean, dry location away from children and livestock.

HHU-2045 HAY HANDLER / UNROLLER REPAIR PARTS LIST

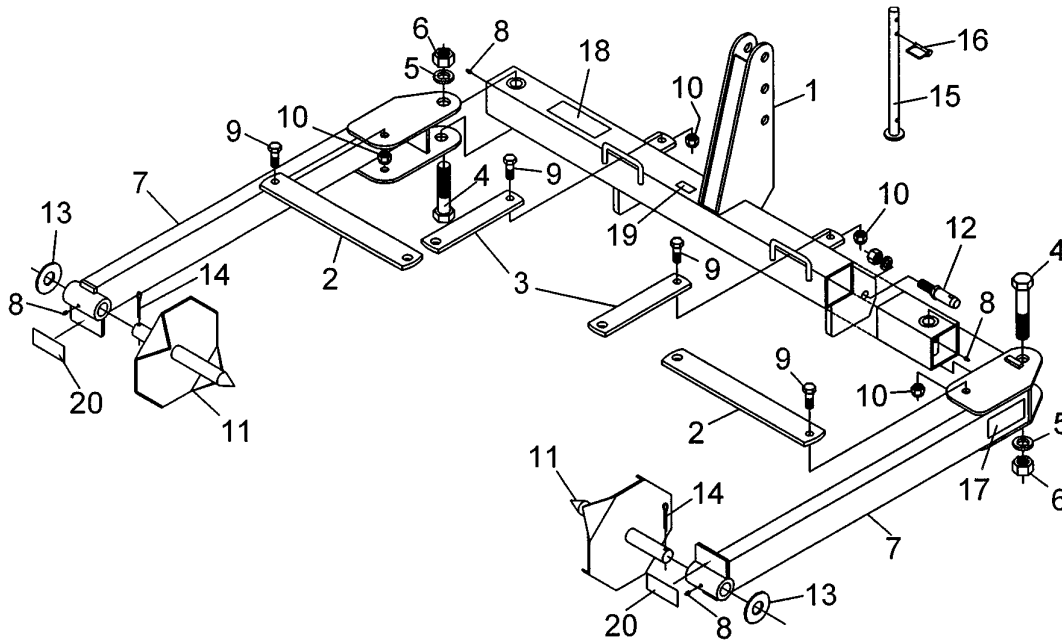

NOTE: The 1 1/4" bolts (Ref. #4) should be inserted with the head of the bolt against the welded tab on the clamp arm. This welded tab ensures that the bolt moves with the arm, which distributes the load over the entire bushing and bolt surface. This installation will result in one bolt head up and the other down.

Ref. No.	Part No.	Description	No. Req'd.
1	831349	Main Frame Weldment	1
2	831341	Cylinder Pivot Arm	2
3	831342	Push Arm	2
4	2503177	Bolt 1 1/4"-7NC x 6 1/2" Hex Head Gr. 2	2
5	2502012	Washer 1 1/4" Springlock	2
6	2500066	Nut 1 1/4"-7NC Full Hex	2
7	831350	Clamp Arm Weldment	2
8	2504049	Drive Zerk 5/16"	4
9	2503002	Bolt 3/4"-10NC x 2" Hex Head Gr. 2	4
10	2500037	Nut 3/4"-10NC Hex Nylock	4
11	831324	Spike Weldment	2
12	590078	Draw Pin (AK-2118)	2
13	2501016	Washer 1 1/2" Flat	2
14	2504003	Cotter Pin 1/4" x 2 1/2"	2
15	343430	Stand Tube Weldment	1
16	590194	Lock Pin 5/16" (AK-2907)	1
17	101027	Safety Sign - Warning (Stand Clear)	2
18	101034	Safety Sign - Caution (Hay Equipment)	1
19	101041	Safety Sign - Notice (2000 Lb. Capacity)	1
20	101209	Safety Sign - Red Reflector	2

SAFETY REQUIREMENTS

AVOID ACCIDENTS BY FOLLOWING ALL OF THE SAFETY REQUIREMENTS LISTED BELOW.

- Machinery should be operated only by those who are responsible and are authorized to do so.
- Stop the engine, lower all equipment, lock the brakes, and remove the ignition key before dismounting from the tractor.
- Never stand between tractor and implement while tractor is being backed to hitch.
- Loose fitting clothing should not be worn, to avoid catching on various parts.
- Detach implement in area where children normally do not play.
- When performing adjustments or maintenance on an implement, first lower it to the ground or block it securely at a workable height.
- Only a qualified operator should be permitted on tractor when in operation; no riders allowed.
- Make certain everyone is in the clear before starting tractor or raising or lowering equipment.
- Operate the tractor and implement only while seated in the driver's seat.
- Reduce speed when transporting mounted implements to avoid bouncing and momentary loss of steering control.
- A heavy load can cause instability of the tractor. Use extreme care during road travel. Slow down on turns and watch out for bumps. Tractor may need front counterweights to counter-balance the weight of the implement.
- Reduce speed on hillsides or curves so there is no danger of tipping.
- Avoid driving too close to the edge of ditches or creeks.
- Do not transport implement on public roads without reflectors and slow moving vehicle emblem in daylight and with approved warning lights at night and other periods of poor visibility.
- Due to the width of some implements, use extra caution on highways, farm roads, and when approaching gates.
- Always be sure the implement is in the proper position for transport.
- Keep alert and watch the front as well as the rear when working with the implement.

OWNER'S/ OPERATOR'S MANUAL

MODEL NO.
HHU-2045

**WHEN ORDERING REPAIR
PARTS, ALWAYS GIVE THE
FOLLOWING INFORMATION:**

1. PART NUMBER
2. PART DESCRIPTION
3. MODEL NUMBER
4. NAME OF ITEM

JANUARY 2014

STATEMENT OF POLICY

It is the policy of Worksaver, Inc. to improve its products where it is possible and practical to do so. Worksaver, Inc. reserves the right to make changes or improvements in design and construction at any time, without incurring the obligation to make these changes on previously manufactured units.

HAY HANDLER / UNROLLER

LIMITED WARRANTY

Worksaver warrants its implements, parts and accessories to be free from defects in materials and workmanship for a period of six (6) months from date of purchase. Upon written approval, Worksaver will repair or exchange without charge any part, which upon examination by Worksaver or its authorized agent, shall disclose to be defective.

This does not apply to (1) parts that have worn out in normal use, (2) parts broken because of improper assembly or operation by the customer, (3) parts accidentally damaged, (4) failure of parts traceable to improper care, (5) parts failing through use of implement for purposes other than those for which it was designed.

The obligations assumed by Worksaver and the limitations expressed herein are in lieu of all other warranties expressed or implied.

WORKSAVER, INC.

P.O. BOX 100 LITCHFIELD, IL 62056-0100 (217) 324-5973
WEB: <http://www.worksaver.com> E-MAIL: sales@worksaver.com